



Product Information
Version 1.0

ZEISS Smartproof 5

Your Integrated Widefield Confocal Microscope
for Surface Analysis in Quality Assurance and Quality Control



Dedicated Design. Guided Workflow. Trusted Output.

- › In Brief
- › The Advantages
- › The Applications
- › The System
- › Technology and Details
- › Service

The versatile ZEISS Smartproof 5 widefield confocal microscope is your integrated system for surface analysis: fast, precise and repeatable.

Put it to work on a wide range of industrial applications – such as roughness and topographical characterization – that come up every day in QA/QC departments, production environments and R&D labs.

This productive and versatile confocal system is driven by powerful ZEISS Efficient Navigation (ZEN) software to bring you the added benefits of maximum user familiarity and increased productivity.

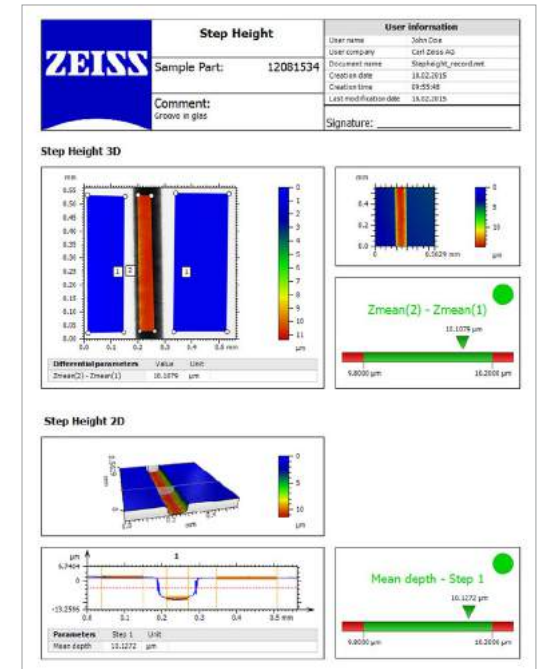

Simpler. More Intelligent. More Integrated.

- › In Brief
- › **The Advantages**
- › The Applications
- › The System
- › Technology and Details
- › Service

Integrated & Robust Design

Smartproof 5 gives you the benefit of a fully integrated system design: optics, electronics and camera are all enclosed in the microscope with the number of cables minimized to eliminate clutter. The entire system is built in a compact manner and its sturdy construction withstands vibration so effectively that there is no need for extra anti-vibration equipment.

Guided Workflows

Thanks to the easy to operate system and to workflow routines in software, Smartproof 5 is well suited to production and process monitoring. Teachable inspection jobs and the workflow-oriented graphical user interface (GUI) guide you through recurring tasks and ensure user-independent data acquisition as a basis for precise and repeatable results.

Trusted Output

Because of its patented Spinning Disc, Aperture Correlation technology, Smartproof 5 minimizes the time to result thus providing a perfect balance between high resolution and high speed. Dedicated ZEISS optics and proven components enable you to work effectively across a broad range of applications. Your Smartproof 5 comes with ConfoMap – the ZEISS version of MountainsMap – the gold standard in characterization software. You easily analyze your data according to international standards and create the respective reports. That's why Smartproof 5 is preferred for routine topography and roughness measurements.

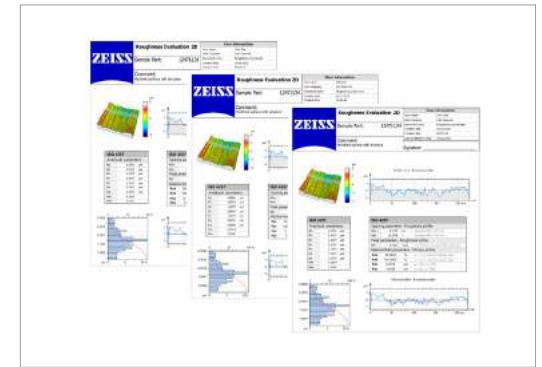
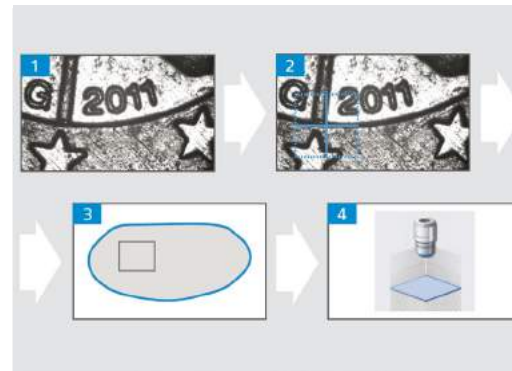

Your Insight into the Technology Behind It

- › In Brief
- › **The Advantages**
- › The Applications
- › The System
- › Technology and Details
- › Service

Integrated & Robust Design for Top Performance

Smartproof 5's robust design offers you the choice of installing and running it in many different working environments – not only in labs but also on the shop floor, even without additional anti-vibration equipment. The scanning stage has a surface area of 300 mm × 240 mm with threaded holes, enabling you to mount holders or fixtures for any parts to be measured. The travel range of

150 mm × 150 mm allows you to analyze different regions on a large part or multiple parts in one pass. Your Smartproof 5 monitors the status of its own mechanical components to ensure optimal performance and preventive detection of potential service issues. The new ZEISS lens class C Epiplan-Apochromat has been especially designed for confocal systems.

These high numerical aperture lenses are optimized for violet light (405 nm) – the wavelength used for widefield confocal imaging – but do also perform excellent in the visible light. These images form the basis for generating topography. True-to-life surface reconstructions can be generated by overlaying texture information generated by wide-field imaging.

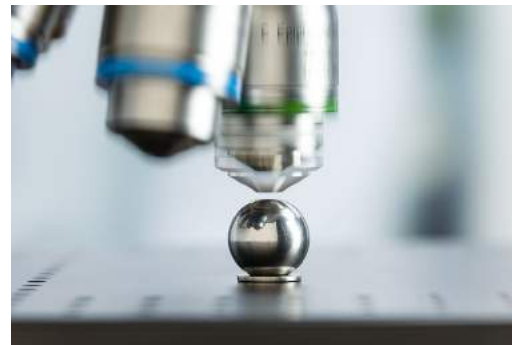

Your Insight into the Technology Behind It

- › In Brief
- › **The Advantages**
- › The Applications
- › The System
- › Technology and Details
- › Service

Guided Workflows for Precise Navigation

Orientation is always easy with Smartproof 5 thanks to its integrated graphical user interface based on the ZEISS Efficient Navigation (ZEN) software that supports seamless macro-to-detail workflows.

The overview image size is 4 mm × 4 mm, within which you can easily define the position to be measured. You can also set up a coordinate system for performing repeatable examinations of samples in the future. The acquired data is automatically transferred to Confomap software, allowing you to process and analyze the 3D properties of your sample. Your workflow can be saved, ready to perform the same microscopic 3D analysis again and again.

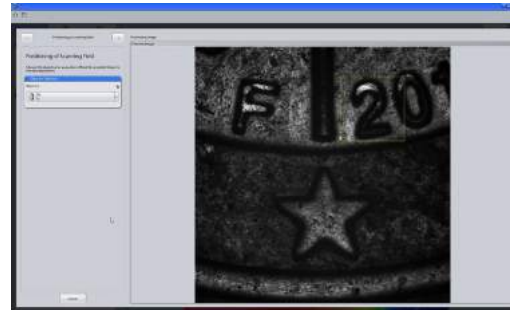

A) Easily navigate on the sample surface via an overview image.

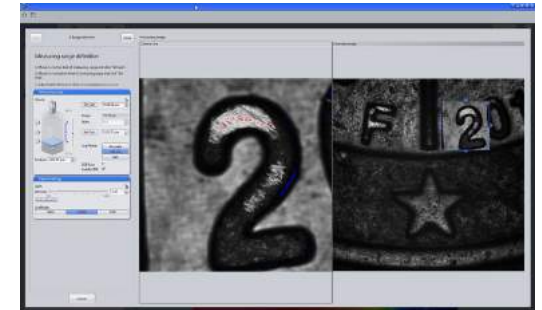

B) A wizard guides you through the image acquisition.

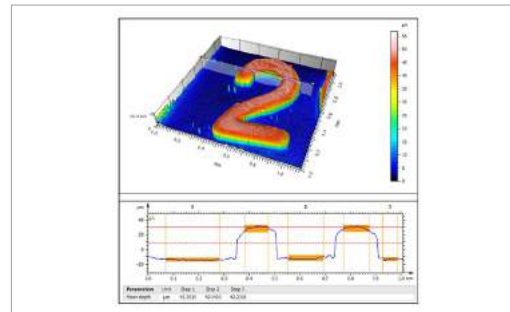

C) Make use of powerful measurement tools in Confomap to analyze your acquired data.

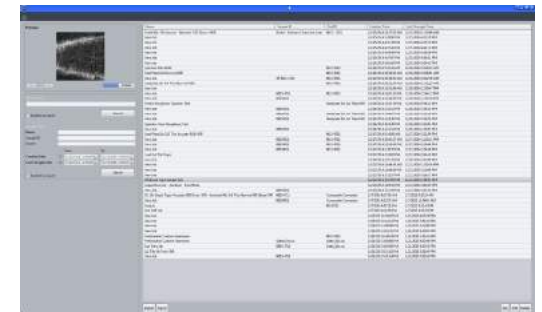
A screenshot of the Confomap software interface showing a structured archive of data. The main window displays a table with multiple columns, including 'Date', 'Time', 'Sample', 'Operator', and 'Status'. The table contains several rows of data, representing individual measurements or acquisitions. The interface also includes a sidebar on the left with various tool options and a top menu bar.

D) Your work is always accessible in a structured archive and can be reused for consecutive analyses.

Your Insight into the Technology Behind It

- › In Brief
- › **The Advantages**
- › The Applications
- › The System
- › Technology and Details
- › Service

Output You Can Trust, Over and Over Again

Smartproof 5 components are motorized so the software can monitor the status of each component. As a result workflows for repetitive acquisitions can be set up easily. By using the powerful ConfoMap software you can analyze geometrical parameters of your sample or carry out roughness analyses in 2D (profile) and 3D (area). The latter are based on ISO standards. Then create your reports with ease using the built-in reporting tools.

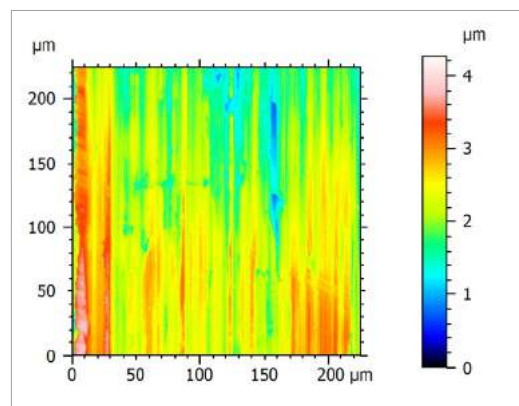

Heightmap surface representation

ISO 25178			
Height Parameters			
Sq	0.4721	µm	Root-mean-square height
Ssk	0.1880		Skewness
Sku	3.3852		Kurtosis
Sp	2.0168	µm	Maximum peak height
Sv	2.2513	µm	Maximum pit height
Sz	4.2680	µm	Maximum height
Sa	0.3677	µm	Arithmetic mean height
Spatial Parameters			
Sal	30.2943	µm	Autocorrelation length
Str	0.2689		Texture-aspect ratio
Std	89.9988	°	Texture direction
Functional Parameters			
Smr	2.3204	%	Areal material ratio

Roughness Parameter according to new standard

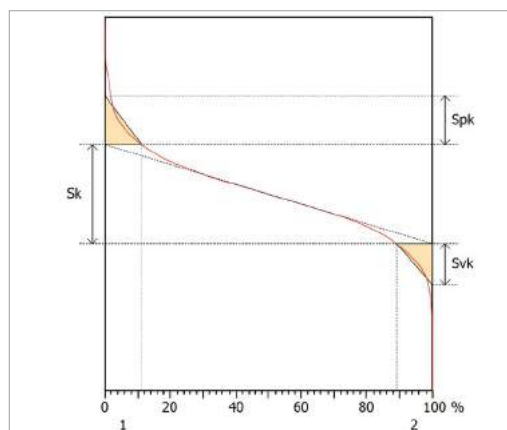

Parameters	Value	Unit
Sk	1.1310	µm
Spk	0.5564	µm
Svk	0.4715	µm
Sr1	11.2355	%
Sr2	89.1355	%
Sa1	0.0313	µm ³ /µm ²
Sa2	0.0256	µm ³ /µm ²

Advanced surface study with Core Roughness analysis

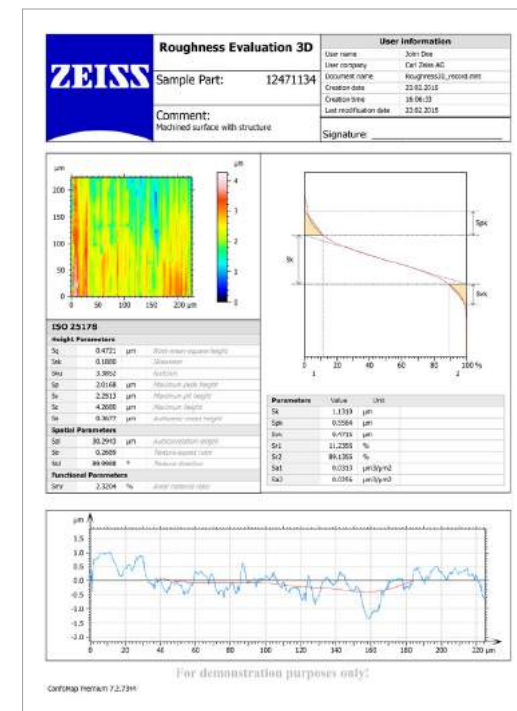

Report with 3D surface and 2D profile

Tailored Precisely to Your Applications

- › In Brief
- › The Advantages
- › **The Applications**
- › The System
- › Technology and Details
- › Service

Typical Applications, Typical Samples	Task	ZEISS Smartproof 5 Offers
Micro-manufacturing	Measurement of 3D geometrical features	The overview image allows you easy navigation to the region of interest. An extensive set of 3D roughness and measuring tools gives you the ideal means of analyzing small surface regions that are inaccessible to conventional measurement devices.
Medical Devices	Measurement of roughness on implants	The confocal method used at a very high level of precision enables non-contact roughness measurements on ceramic and metallic surfaces. 3D roughness parameters provide additional important information to guarantee optimal performance of your product.
Micro-optics	Quantification of form parameters	Confocal imaging allows geometric measurements on soft and sensitive surfaces without modifying the results. ConfoMap software offers a large number of surface characterization parameters.
Electronics	Qualification of traces	Highly reflective traces on dark substrates can be imaged all at once thanks to the powerful HDR-function. A valid qualification of the geometry can easily be performed.
Automotive & Aerospace	Roughness, edge and wear measurements	The fast widefield aperture correlated confocal acquisition combined with the fast and very sensitive detector provides fast, precise and accurate measurement results. In addition to the common 2D roughness values, 3D parameters give you a much better understanding of your surface properties.

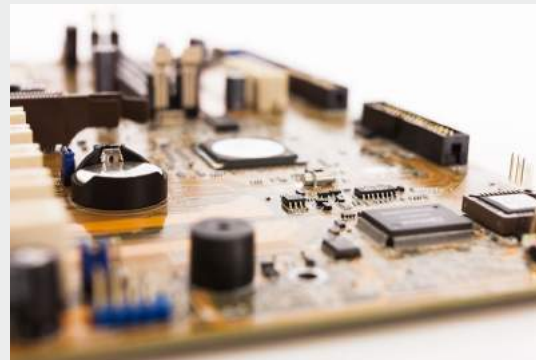

ZEISS Smartproof 5 at Work

- › In Brief
- › The Advantages
- › **The Applications**
- › The System
- › Technology and Details
- › Service

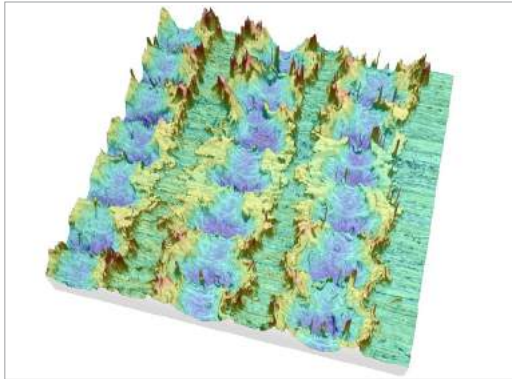

Laser structured surface, 3D view of color coded height map with texture overlay, C Epiplan-Apochromat 50x/0.95

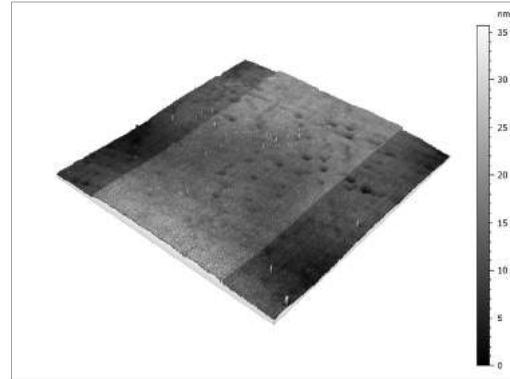

8 nm step height standard, height map, C Epiplan-Apochromat 50x/0.95

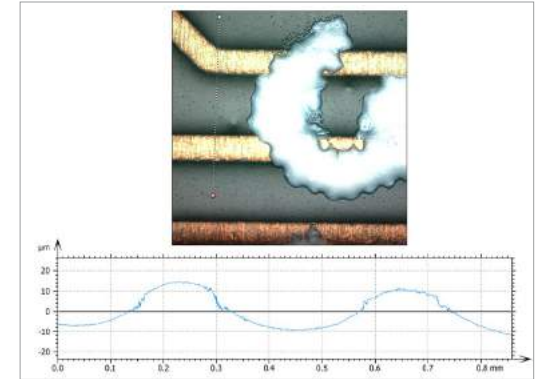

Profile measurement of a circuit board, 3D view with true color overlay, C Epiplan-Apochromat 10x/0.4

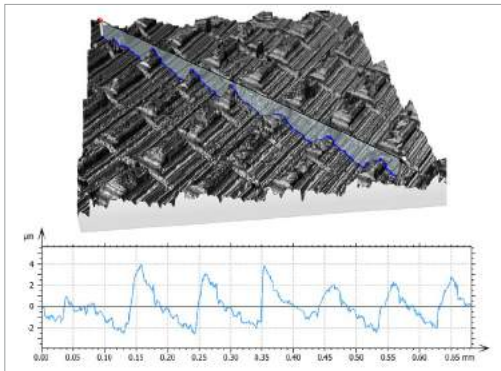

Milled aluminum surface, 3D view with texture overlay, C Epiplan-Apochromat 20x/0.7

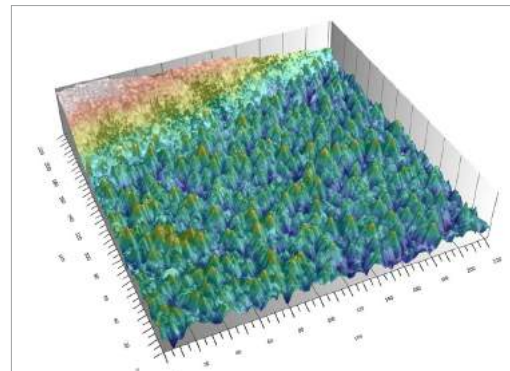

Silver finger on solar cell surface, 3D view of color coded height map with texture overlay, C Epiplan-Apochromat 50x/0.95

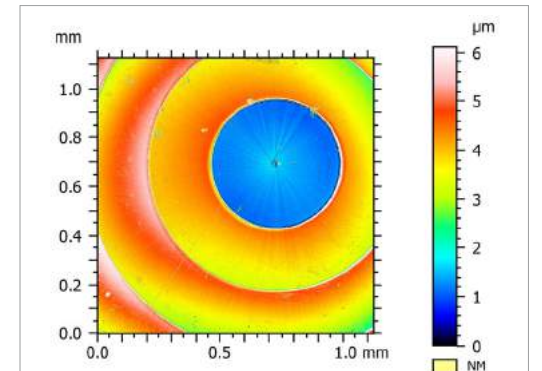

Diffractive optics, color coded height map, C Epiplan-Apochromat 10x/0.4

Your Flexible Choice of Components

- › In Brief
- › The Advantages
- › The Applications
- › **The System**
- › Technology and Details
- › Service



1 Microscope

Smartproof 5 consisting of:

- Scan head with fine Z-drive and 4-megapixel camera
- Stand with coarse Z-drive

2 Objectives

- EC Epiplan-Neofluar 2.5x/0.06 (always included)
- C Epiplan-Apochromat 5x/0.2
- C Epiplan-Apochromat 10x/0.4
- C Epiplan-Apochromat 20x/0.7
- C Epiplan-Apochromat 50x/0.95

- LD C Epiplan-Apochromat 50x/0.6 (long working distance)
- LD C Epiplan-Neofluar 100x/0.75 (long working distance)

3 Stages

- Scanning stage, 150 mm × 150 mm
- Fixed stage

4 Computer System

- PC system with Smartproof ZEN software
- Monitor
- 3D mouse for control of XYZ axes

System Overview

- › In Brief
- › The Advantages
- › The Applications
- › **The System**
- › Technology and Details
- › Service

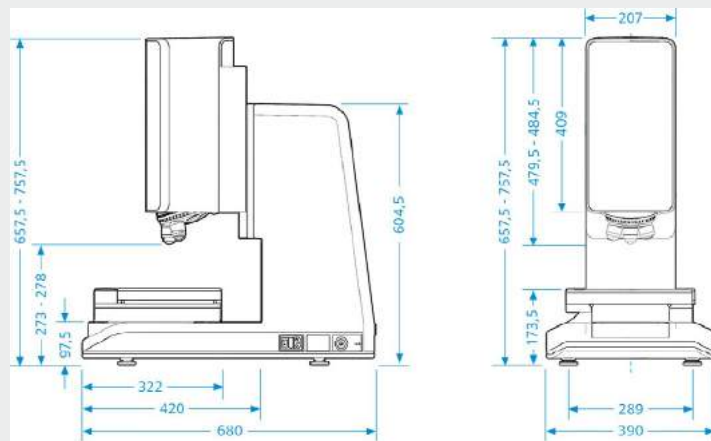

System Components

Optical Unit	Containing the fine Z-drive, the illumination with 405 nm, red, green and blue light, the widefield spinning disc aperture correlation module, 4 megapixel camera and 6 times objective nosepiece.
Objectives	2.5x lens for overview and navigation, 5x to 100x high numerical aperture lenses, specially designed for 405 nm as well as white light.
Stage	Powered by a stepper motor with integrated controller, which makes it possible to move to relevant areas of the sample in a reproducible manner. Alternatively, a fixed stage is available.
Stand	Powered by a motorized Z-drive for sample height adjustment and including controlling electronics.
3D Mouse	Offering intuitive operation of all XYZ axes, including coarse and fine Z-drive
PC	Containing the Smartproof 5 application software and connected to the camera via USB 3 and to the stand via USB 2.

Technical Specifications

- › In Brief
- › The Advantages
- › The Applications
- › The System
- › **Technology and Details**
- › Service

Image Field According to Objective Magnification	Objective Magnification and Numerical Aperture	Field of View ($\mu\text{m} \times \mu\text{m}$)	Working Distance (mm)
	5x/0.2	2250 × 2250	21
	10x/0.4	1125 × 1125	5.4
	20x/0.7	562 × 562	1.3
	50x/0.95	225 × 225	0.22
	50x/0.6	225 × 225	7.6
	100x/0.75	112 × 112	4.0
Image Pixel Resolution	2048 × 2048 pixels		
Lateral Resolution (Line-space Pattern) Using 50x/0.95	0.13 μm		
Lateral Measurement Uncertainty ¹⁾	$\pm 0.1 \mu\text{m} \pm 0.008 \times L$ (or better)		
Vertical Measurement Uncertainty ^{1), 2)}	$\pm 0.1 \mu\text{m} \pm 0.012 \times L$ (or better)		
Movement Resolution of Z-Drive	1 nm		
Illumination	405 nm LED for confocal imaging and RGB LEDs for color imaging		
Camera Frame Rate	50 fps at 2048 × 2048 pixels using USB 3		
Color Depth	10 bit		
Height Scanning Range	Up to 5 mm		
Maximum Height of Work Piece	100 mm		
Maximum Weight of Work Piece	5 kg		
Scanning Stage Size and Travel Range in X and Y	300 mm × 240 mm 150 mm × 150 mm		
Image Data Processing and Measurements	2D: distance, height, angle, constructed elements, profile roughness based on ISO 4287		
	3D: lateral distances, 3D distance, height, angle, constructed points, area, volume, areal roughness according to ISO 25178		
	Additional: Alignment, form removal, filters, noise cut, reporting.		

¹⁾ When measuring a standard sample with C-Epiplan-Apochromat 50x/0.95 under setup conditions recommended in the user manual.

²⁾ When using the "accurate"-mode for acquisition

Count on Service in the True Sense of the Word

- › In Brief
- › The Advantages
- › The Applications
- › The System
- › Technology and Details
- › **Service**

By choosing Smartproof 5 from ZEISS, you've put reliability and availability among your top priorities for quality assurance and quality control.

Your Performance. Our Support.

Your Smartproof 5 is designed for a long, productive life. However, should you ever have a question about the technology or how to use it, a dedicated team of experts will be available by phone, e-mail or remote access.

Because Your Standards Are Uncompromising: Service Agreements with Connected Assistance

If you rely on a high level of availability, you are well served by our ZEISS Protect Service Agreements.

You can be sure of priority service and shorter response times as well as rapid repairs – and with Protect premium, all of that comes for a flat fee.



Benefit from the optimized performance of your microscope system with services from ZEISS – now and for years to come.

>> www.zeiss.com/microservice



Carl Zeiss Microscopy GmbH
07745 Jena, Germany
microscopy@zeiss.com
www.zeiss.com/smartproof

